

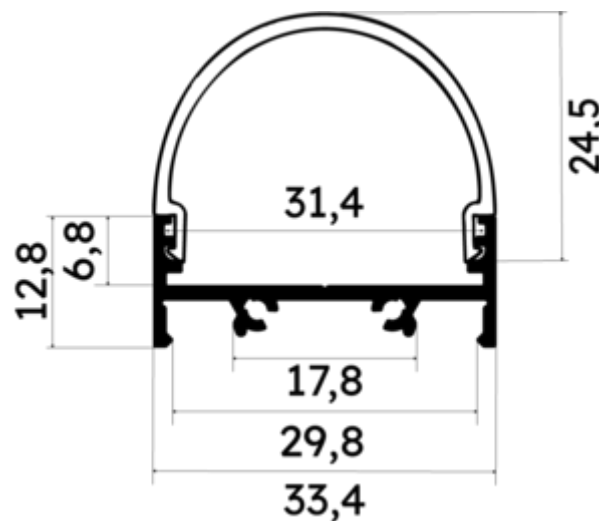

PR2030-01-D9-BLANC

Profilé en saillie



Caractéristiques techniques





LARGEUR	33,4mm
LARGEUR INTÉRIEURE	31,0mm
HAUTEUR	3,27 cm
MATIÈRE	Aluminium
ACCESSOIRE INCLUS	Diffuseur D9
CONDITIONNEMENT	1





Références

NOM COMMERCIAL RÉF. CONSTRUCTEUR	LONGUEUR	TYPE DE CAPOT	COULEUR DU PRODUIT
PR2030-01-D9-BLANC ENG030000000118	2m	Opale	Blanc
PR2030-01-D9-BLANC-SP ENG031000000107	1,0cm	Opale	Blanc

Accessoires associés non inclus

NOM COMMERCIAL RÉF. CONSTRUCTEUR	DESCRIPTION	COULEUR	MATIERE	ILLUSTRATION
PR2000-7 ENG0309906000015	PR2000 KIT DE SUSPENSION SANS COURANT DE COLORIS GRIS POUR PROFILE LONGUEUR DE 1.50M	Gris	Acier	
PR2030-0203-5-180 ENG0309906000091	PR2030-0203-5 CONNECTEUR POUR PROFILE DROIT 180 DEGRES DE COLORIS GRIS EN MATIERE ALUMINIUM	Gris	Aluminium	
PR2000-2Y2 ENG0309902000030	PR2000 CLIPS DE FIXATION Y2 INOX VENDU PAR LOT DE DEUX UNITES POUR FIXER LE PROFILE	Gris	Inox	
PR2000-3-BLANC ENG0309903000001	PR2000 KIT DE SUSPENSION AVEC COURANT DE COLORIS BLANC POUR PROFILE LONGUEUR DE 2.50M	Blanc	Acier chromé	



NOM COMMERCIAL RÉF. CONSTRUCTEUR	DESCRIPTION	COULEUR	MATIERE	ILLUSTRATION
PR2000-FIX16-BLANC-SP ENG0319906000005	PR2000 FIXATION PLATE EN ALUMINIUM DE COLORIS BLANC POUR PROFILE LONGUEUR SUR-MESURE VENDU AU CENTIMETRE	Blanc	Aluminium	
PR2030-01-1-BLANC ENG0309901000110	PR2030-01 BOUCHON DE FINITION EN MATIERE PLASTIQUE DE COLORIS BLANC VENDU PAR LOT DE DEUX UNITES	Blanc	ABS	
PR2030-01-D9-1 ENG0309901000113	PR2030-01-D9 BOUCHON DE FINITION TRANSPARENT POUR PROFILE AVEC CAPOT D9 VENDU PAR 2	Opale	ABS	
PR2030-D9-1 ENG0309901000131	PR2030 BOUCHON DE FINITION EN MATIERE PLASTIQUE TRANSPARENT POUR CAPOT D9 UNIQUEMENT VENDU PAR LOT DE DEUX UNITES	Opale	PMMA	